

Chapter 2

Introduction to the Principles of Feedback

Topics to be covered include:

- ❖ An industrial motivational example;
- ❖ A statement of the fundamental nature of the control problem;
- ❖ The idea of inversion as the central ingredient in solving control problems;
- ❖ Evolution from open loop inversion to closed loop feedback solutions.

We will see that feedback is a key tool that can be used to modify the behaviour of a system.

This behaviour altering effect of feedback is a key mechanism that control engineers exploit deliberately to achieve the objective of acting on a system to ensure that the desired performance specifications are achieved.

A motivating industrial example

We first present a simplified, yet essentially authentic, example of an industrial control problem. The example, taken from the steel industry, is of a particular nature, however the principal elements of specifying a desired behaviour, modeling and the necessity for trade-off decisions are generic.

Photograph of Bloom Caster

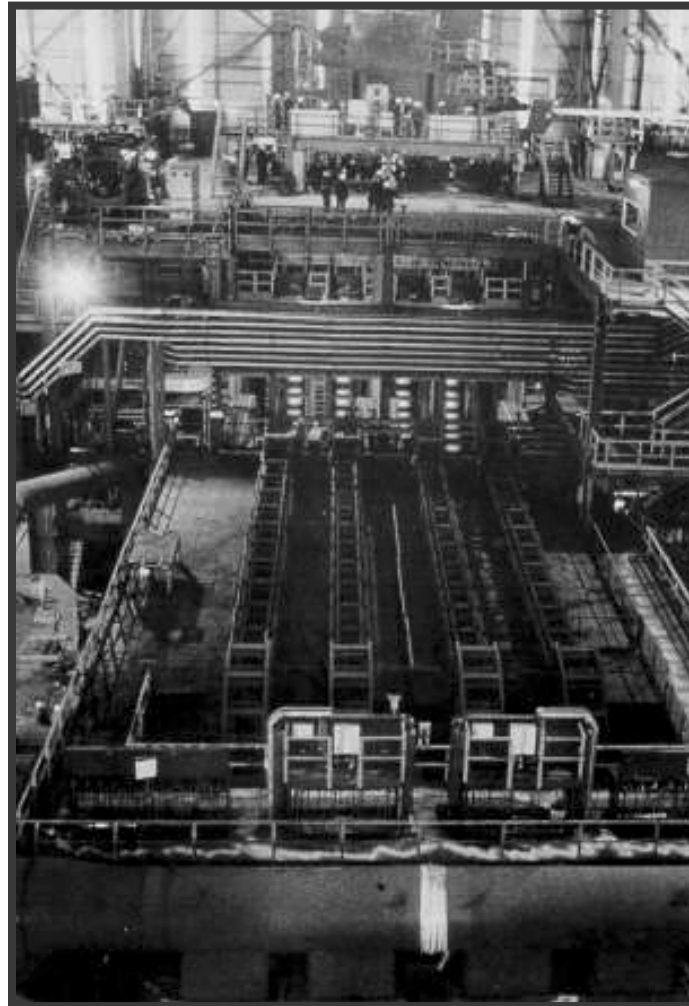

Process schematic of an Industrial Bloom Caster

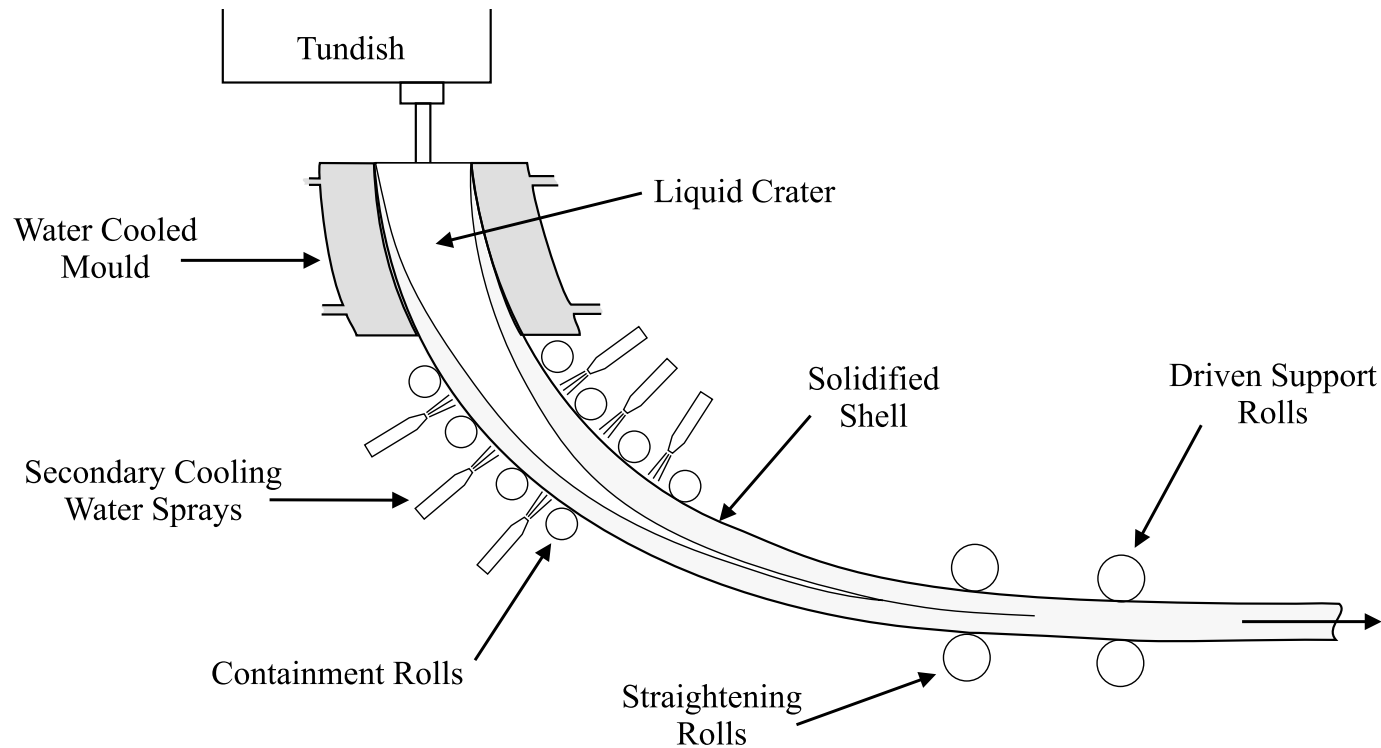

Continuous caster. Typical bloom (left) and simplified diagram (right)

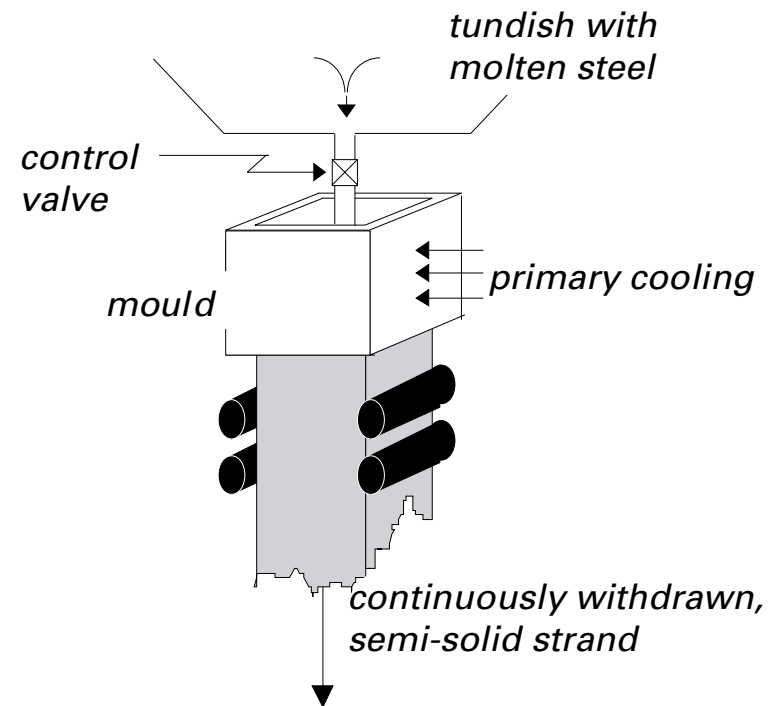
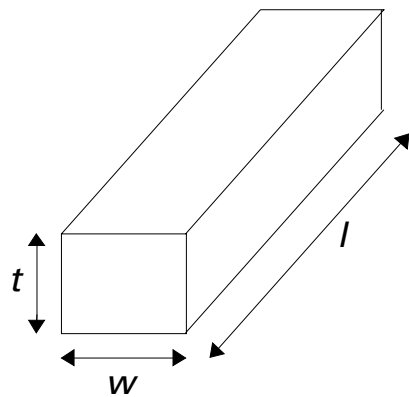

Operators viewing the mould



The cast strip in the secondary cooling chamber

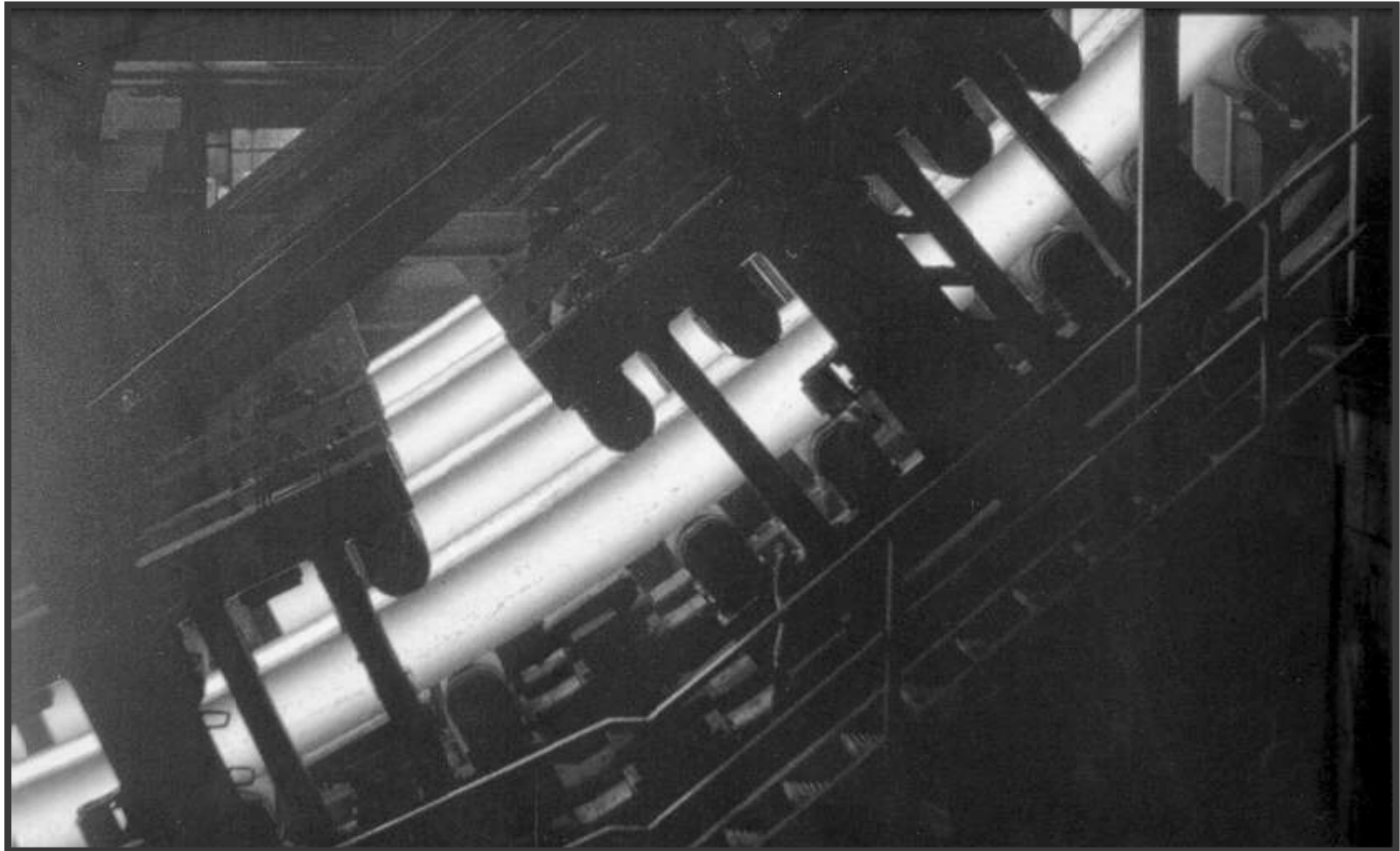

Performance specifications

The key performance goals for this problem are:

- ❖ *Safety*: Clearly, the mould level must never be in danger of overflowing or emptying as either case would result in molten metal spilling with disastrous consequences.
- ❖ *Profitability*: Aspects which contribute to this requirement include:
 - ◆ Product quality
 - ◆ Maintenance
 - ◆ Throughput

Modeling

To make progress on the control system design problem, it is first necessary to gain an understanding of how the process operates. This understanding is typically expressed in the form of a mathematical model.

h^* : commanded level of steel in mould

$h(t)$: actual level of steel in mould

$v(t)$: valve position

$\sigma(t)$: casting speed

$q_{in}(t)$: inflow of matter into the mould

$q_{out}(t)$: outflow of matter from the mould

Model as simple tank

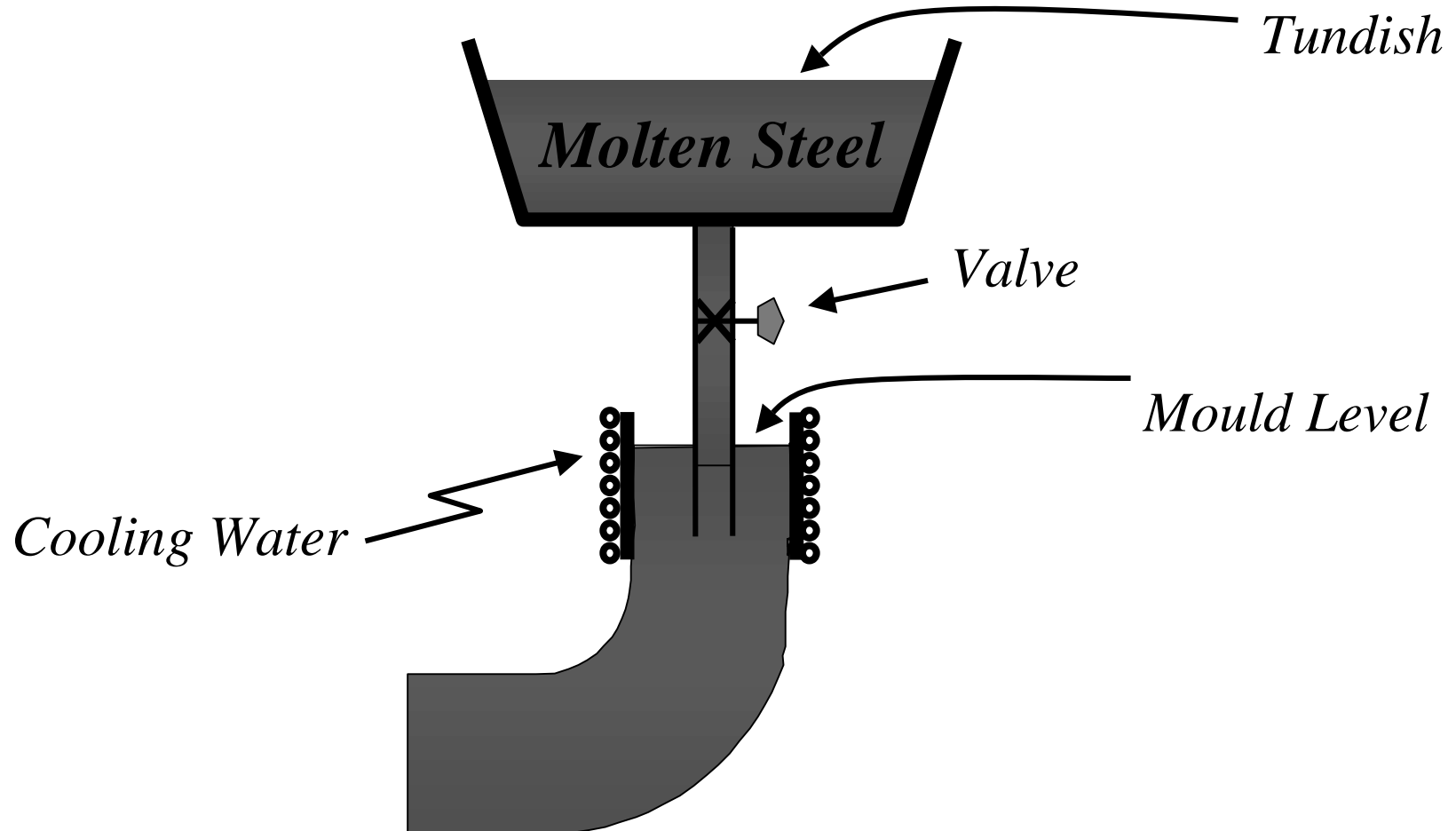

Block diagram of the simplified mould level dynamics, sensors and actuators

These variables are related as shown below:

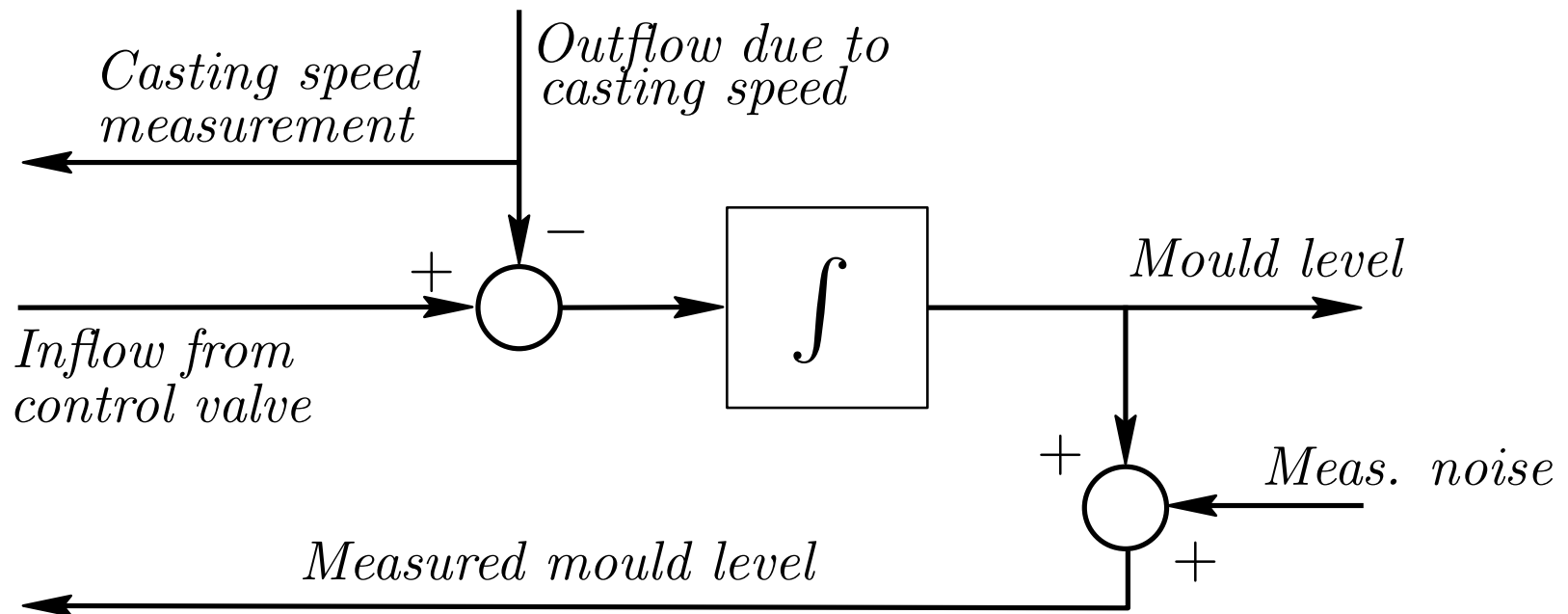

Feedback and Feedforward

We will find later that the core idea in control is that of inversion. Moreover, inversion can be conveniently achieved by the use of two key mechanisms (namely, feedback and feedforward).

Figure 2.4: *Model of the simplified mould level control with feedforward compensation for casting speed*

Suggested Control Strategy:

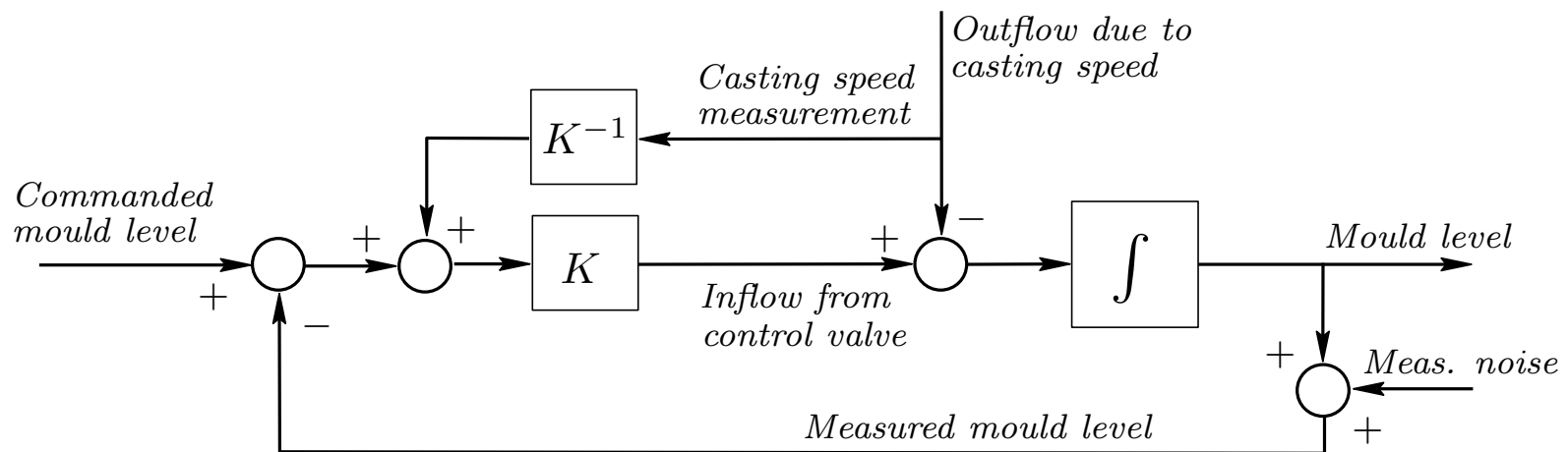

Note that this controller features joint feedback and a preemptive action (feedforward).

A first indication of trade-offs

On simulating the performance of the above control loop for $K=1$ and $K=5$, see Figure 2.5, we find that the smaller controller gain ($K=1$) results in a slower response to a change in the mould level set-point. On the other hand, the larger controller gain ($K=5$), results in a faster response but also increases the effects of measurement noise as seen by the less steady level control and by the significantly more aggressive valve movements.

Figure 2.5: *A first indication of trade-offs: Increased responsiveness to set-point changes also increases sensitivity to measurement noise and actuator wear.*

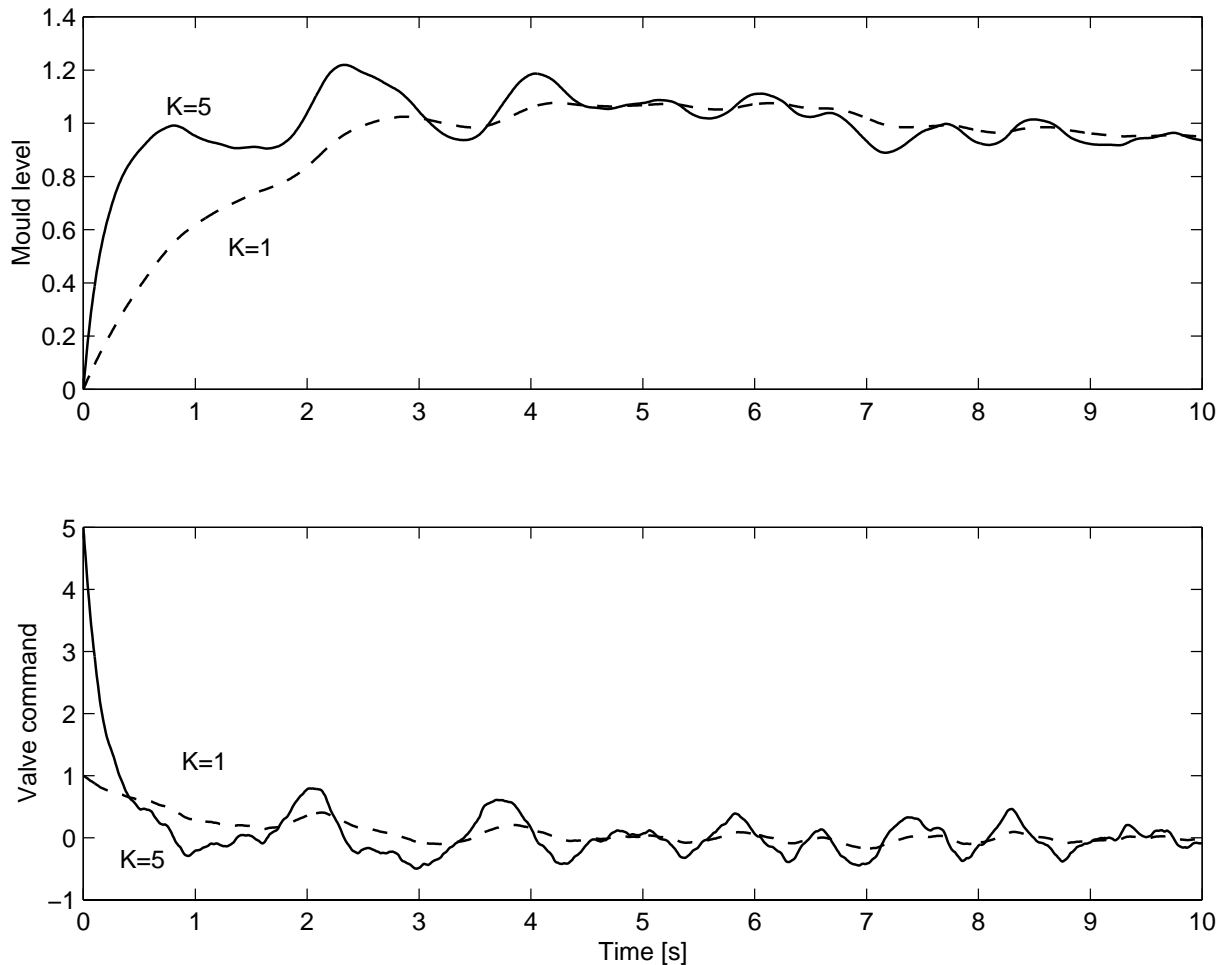

Question

We may ask if these trade-offs are unavoidable or whether we could improve on the situation by such measures as:

- ❖ better modelling
- ❖ more sophisticated control system design

This will be the subject of the rest of our deliberations.

(Aside: Actually the trade-off is fundamental as we shall see presently).

Definition of the control problem

Abstracting from the above particular problem, we can introduce:

Definition 2.1:

The central problem in control is to find a technically feasible way to act on a given process so that the process behaves, as closely as possible, to some desired behaviour. Furthermore, this approximate behaviour should be achieved in the face of uncertainty of the process and in the presence of uncontrollable external disturbances acting on the process.

Prototype solution to the control problem via inversion

One particularly simple, yet insightful way of thinking about control problems is via inversion. To describe this idea we argue as follows:

- ❖ say that we know what effect an action at the input of a system produces at the output, and
- ❖ say that we have a desired behaviour for the system output, then one simply needs to invert the relationship between input and output to determine what input action is necessary to achieve the desired output behaviour.

Figure 2.6: *Conceptual controller*

The above idea is captured in the following diagram:

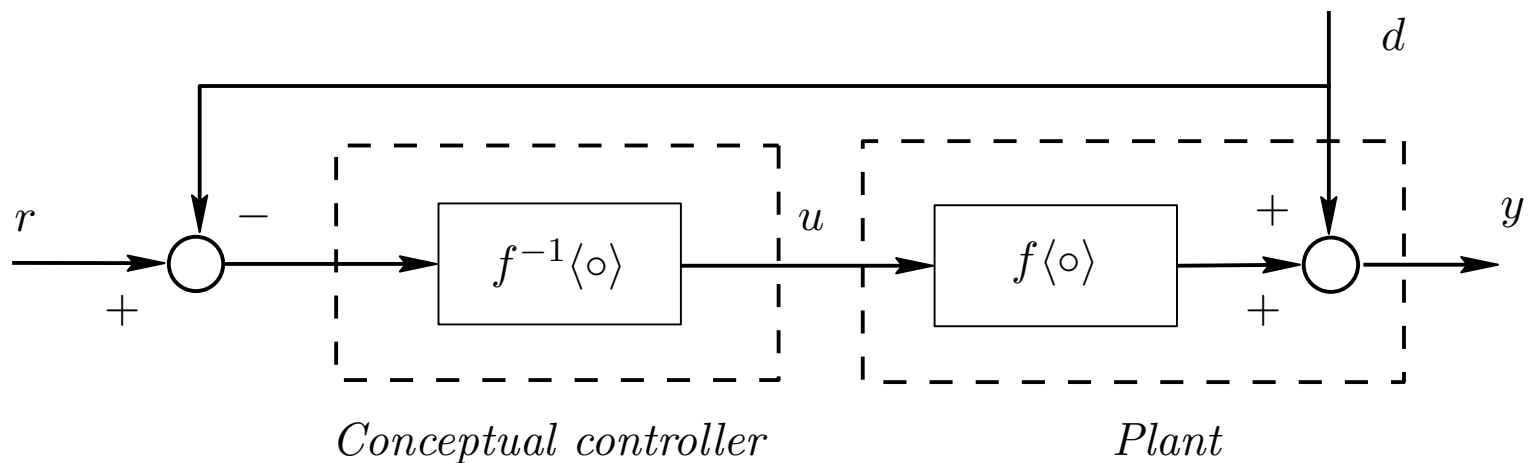

We will actually find that the inverse solution given on the last slide holds very generally.

Thus, all controllers implicitly generate an inverse of the process, in so far that this is feasible. However, the details of controllers will differ with respect to the mechanism used to generate the required approximate inverse.

High gain feedback and inversion

We next observe that there is a rather intriguing property of feedback, namely that it implicitly generates an approximate inverse of dynamic transformations, without the inversion having to be carried out explicitly.

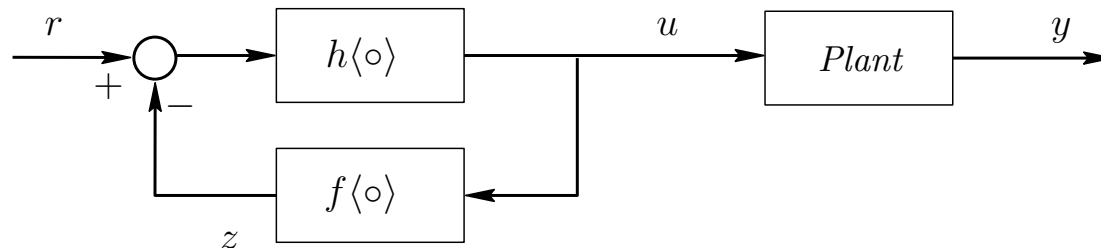

Figure 2.7:
*Realisation of
conceptual controller*

The loop implements an approximate inverse of $f \langle \circ \rangle$, i.e. $u = f \langle r \rangle$, if

$$r - h^{-1} \langle u \rangle \approx r$$

Specifically,

$$u = h\langle r - z \rangle = h\langle r - f\langle u \rangle \rangle$$

or

$$h^{-1}\langle u \rangle = r - f\langle u \rangle$$

Hence

$$\begin{aligned} u &= f^{-1}\langle r - h^{-1}\langle u \rangle \rangle \\ &\cong f^{-1}\langle r \rangle \end{aligned}$$

Provided $h^{-1}\langle u \rangle$ is small, i.e. $h\langle \ \rangle$ is *high gain*.

The above equation is satisfied if $h^{-1}\langle u \rangle$ is large. We conclude that an approximate inverse is generated provided we place the model of the system in a high gain feedback loop.

Example 2.3

Assume that a plant can be described by the model

$$\frac{dy(t)}{dt} + 2\sqrt{y(t)} = u(t)$$

and that a control law is required to ensure that $y(t)$ follows a slowly varying reference.

One way to solve this problem is to construct an inverse for the model which is valid in the low frequency region. Using the architecture in Figure 2.7, we obtain an approximate inverse, provided that $h(s)$ has large gain in the low frequency region.

Figure 2.8: *Tank level control using approximate inversion*

Simulating the resultant controller gives the results below:

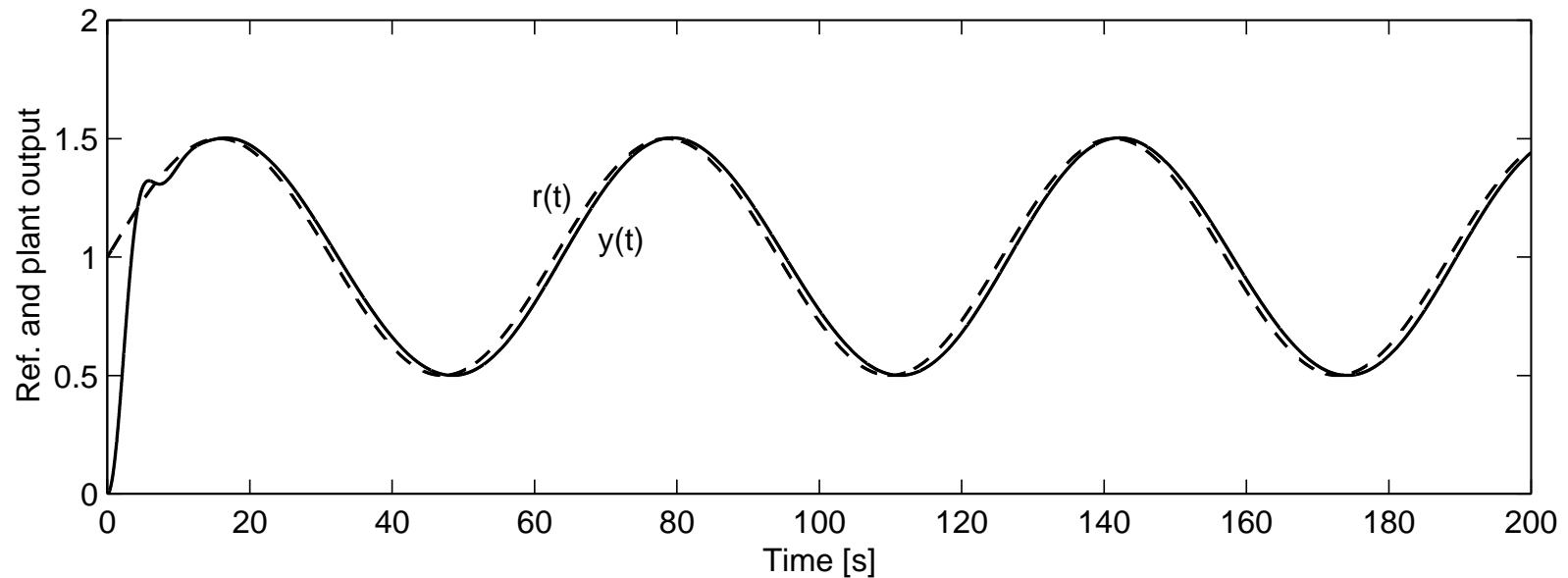

From open to closed loop architectures

Unfortunately, the above methodology will not lead to a satisfactory solution to the control problem unless:

- ❖ the model on which the design of the controller has been based is a very good representation of the plant,
- ❖ the model and its inverse are stable, and
- ❖ disturbances and initial conditions are negligible.

We are thus motivated to find an alternative solution to the problem which retains the key features but which does not suffer from the above drawbacks.

Figure 2.9: *Open loop control with built-in inverse*

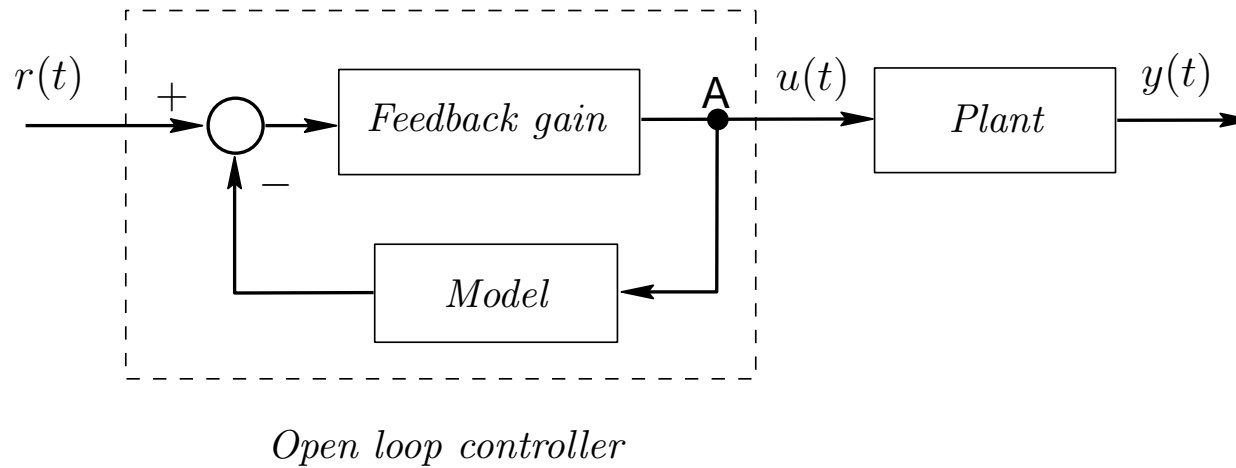
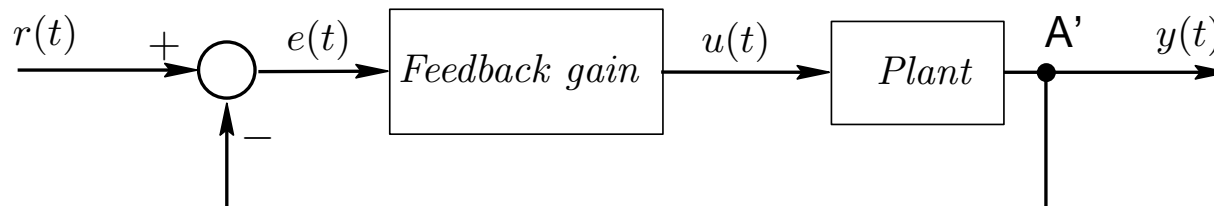

Figure 2.10: *Closed loop control*



-
- ❖ The first thing to note is that, provided the model represents the plant exactly, and that all signals are bounded (i.e. the loop is stable), then both schemes are equivalent, regarding the relation between $r(t)$ and $y(t)$. The key differences are due to disturbances and different initial conditions.
 - ❖ In the open loop control scheme the controller incorporates feedback internally, i.e. a signal at point A is fed back.

-
- ❖ In the closed loop scheme, the feedback signal depends on what is actually happening in the plant since the true plant output is used.

We will see later that this modified architecture has many advantages including:

- ◆ insensitivity to modelling errors;
- ◆ insensitivity to disturbances in the plant (*that are not reflected in the model*).

Trade-offs involved in choosing the feedback gain

The preliminary insights of the previous two sections would seem to imply that all that is needed to generate a controller is to put high gain feedback around the plant. This is true in so far that it goes. However, nothing in life is cost free and this also applies to the use of high gain feedback.

For example, if a plant disturbance leads to a non-zero error $e(t)$, in Figure 2.10, then high gain feedback will result in a very large control action $u(t)$. This may lie outside the available input range and thus invalidate the solution.

Another potential problem with high gain feedback is that it is often accompanied by the very substantial risk of instability. Instability is characterised by self sustaining (or growing) oscillations. As an illustration, the reader will probably have witnessed the high pitch whistling sound that is heard when a loudspeaker is placed too close to a microphone. This is a manifestation of instability resulting from excessive feedback gain. Tragic manifestations of instability include aircraft crashes and the Chernobyl disaster in which a runaway condition occurred.

Yet another potential disadvantage of high loop gain was hinted at in the mould level example. There we saw that increasing the controller gain lead to increased sensitivity to measurement noise. (Actually, this turns out to be generically true).

In summary, high loop gain is desirable from many perspectives but it is also undesirable when viewed from other perspectives. Thus, when choosing the feedback gain one needs to make a conscious trade-off between competing issues.

The previous discussion can be summarised in the following statement:

High loop gain gives approximate inversion which is the essence of control. However, in practice, the choice of feedback gain is part of a complex web of design trade-offs. Understanding and balancing these trade-offs is the essence of control system design.

Measurements

- ❖ Finally, we discuss the issue of measurements (i.e. what it is we use to generate the feedback signal).
- ❖ A more accurate description of the feedback control loop including sensors is shown in Figure 2.11.

Figure 2.11: *Closed loop control with sensors*

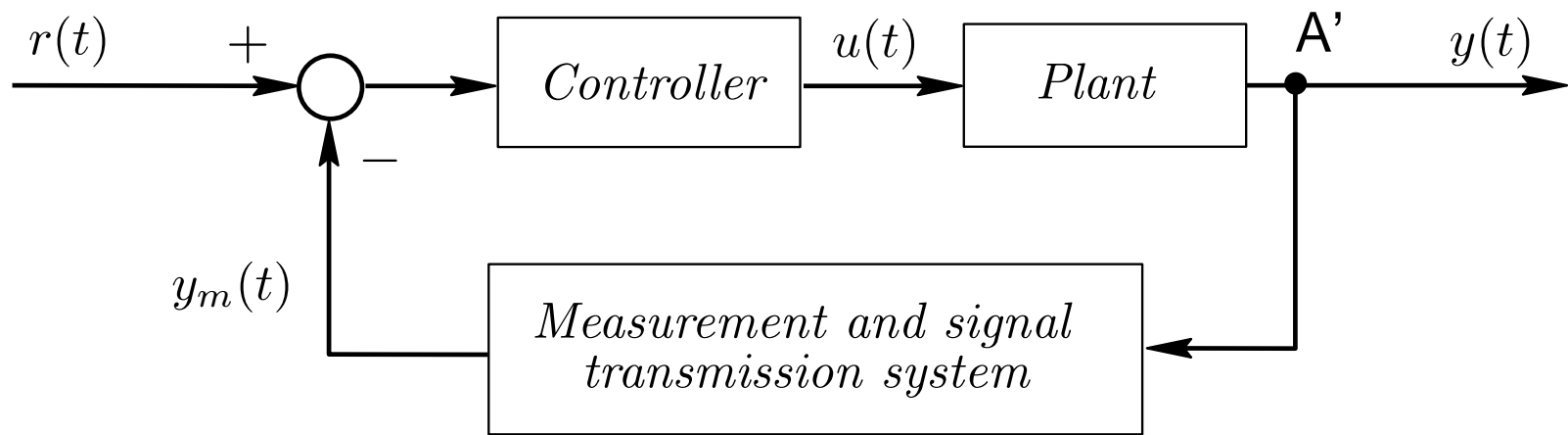

Desirable attributes of sensors

- ❖ *Reliability*. It should operate within the necessary range.
- ❖ *Accuracy*. For a variable with a constant value, the measurement should settle to the correct value.
- ❖ *Responsiveness*. If the variable changes, the measurement should be able to follow the changes. Slow responding measurements can, not only affect the quality of control but can actually make the feedback loop unstable. Loop instability may arise even though the loop has been designed to be stable assuming an exact measurement of the process variable.

-
- ❖ *Noise immunity.* The measurement system, including the transmission path, should not be significantly affected by exogenous signals such as measurement noise.
 - ❖ *Linearity.* If the measurement system is not linear, then at least the nonlinearity should be known so that it can be compensated.
 - ❖ *Non intrusive.* The measuring device should not significantly affect the behaviour of the plant.

Figure 2.12: *Typical feedback loop*

In summary, a typical feedback loop (including sensor issues) is shown below.

